

AMOR



HOUSE



BUILDING

TIPS

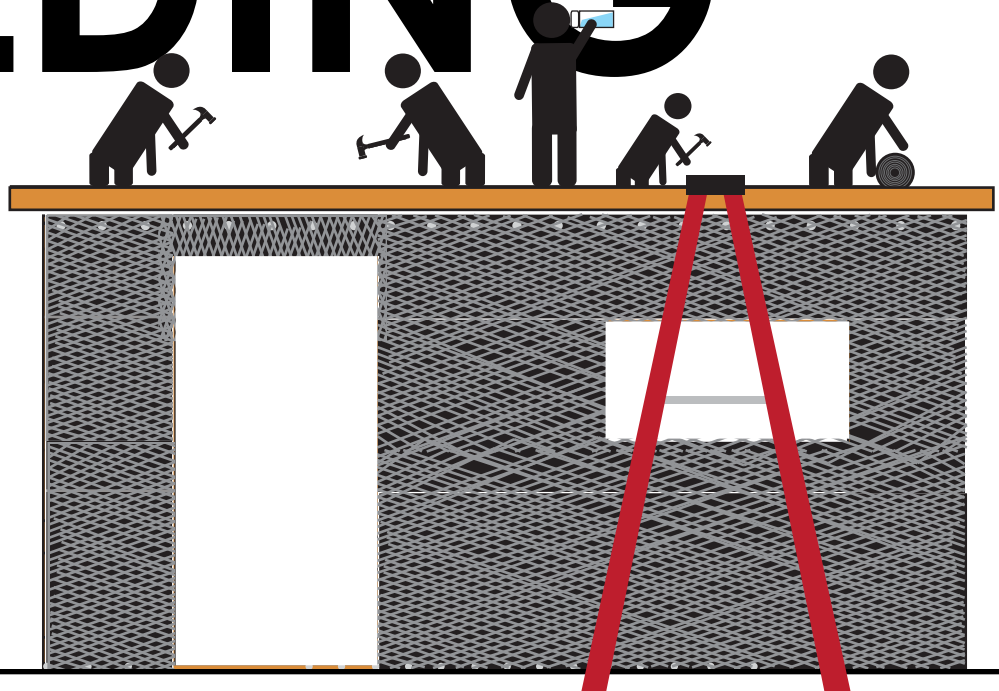

BAILING WIRE

1

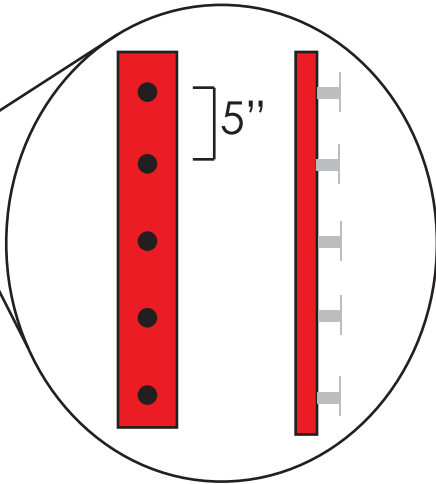
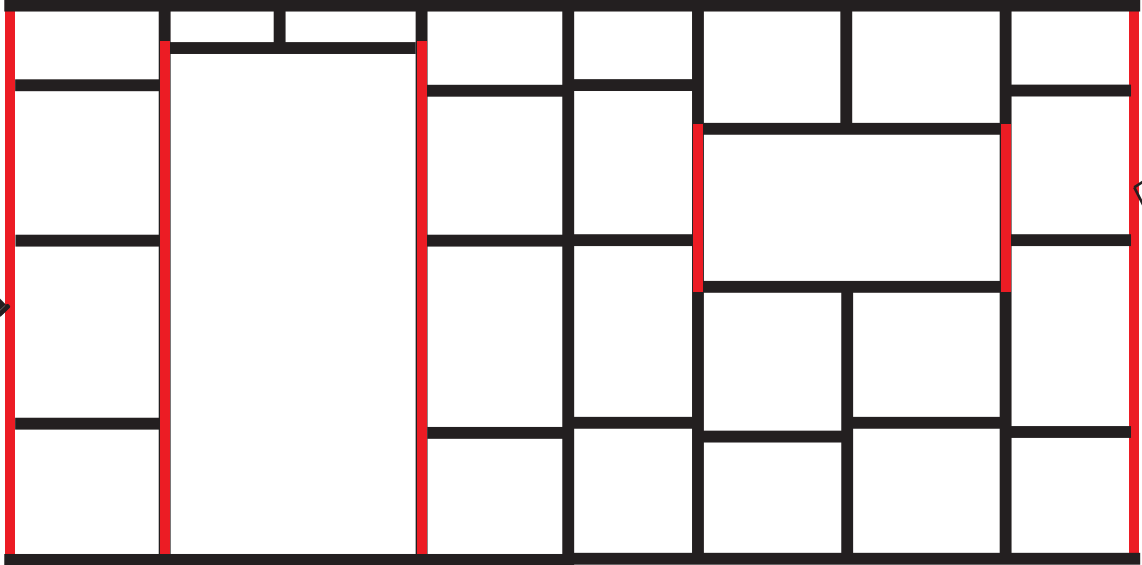

2

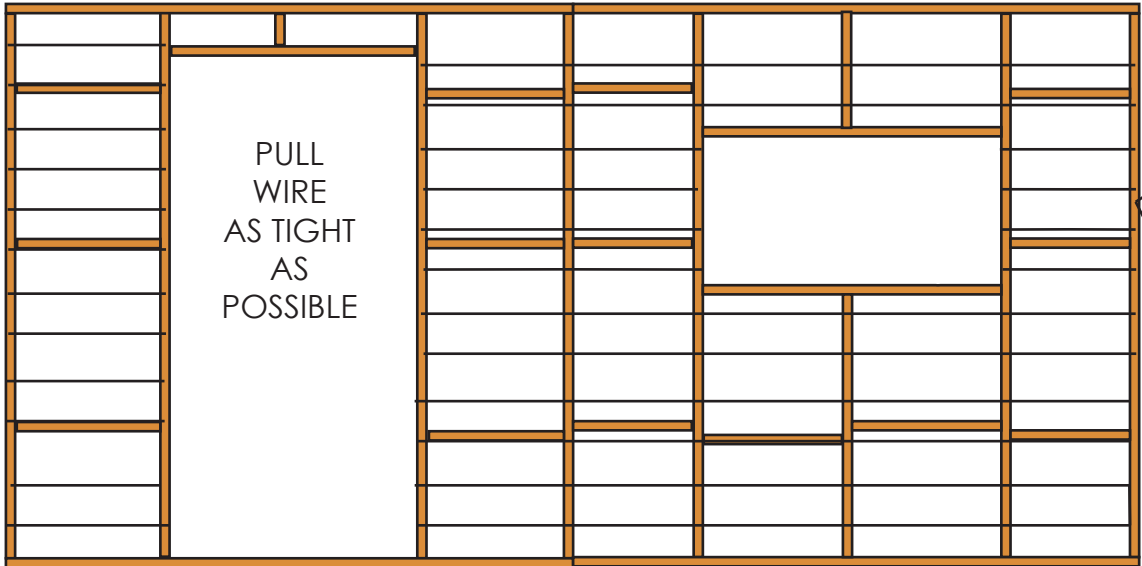

PULL
WIRE
AS TIGHT
AS
POSSIBLE

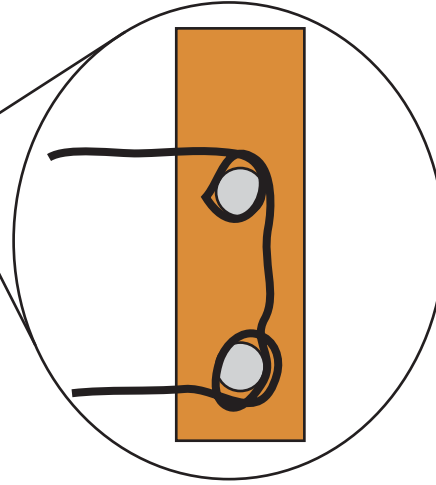

TAR PAPER

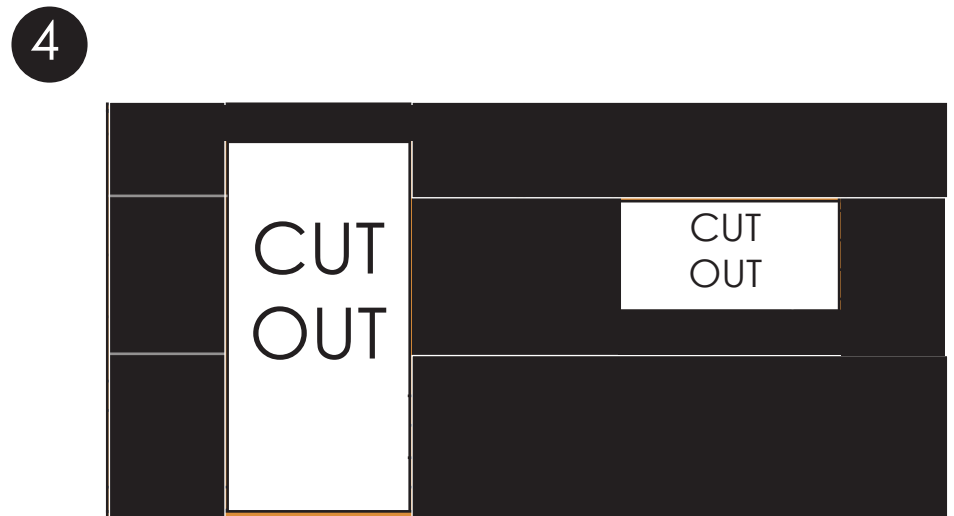
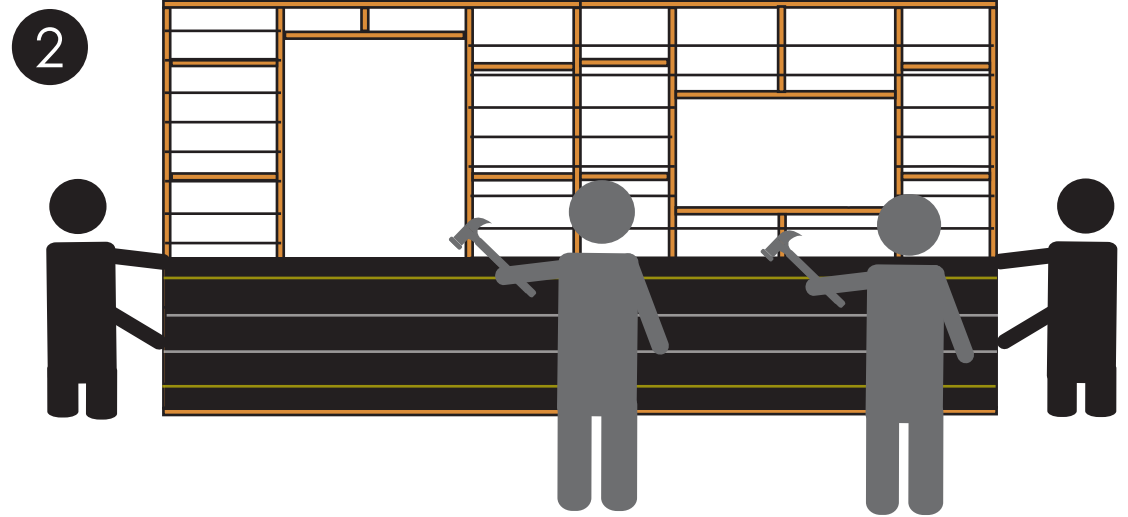
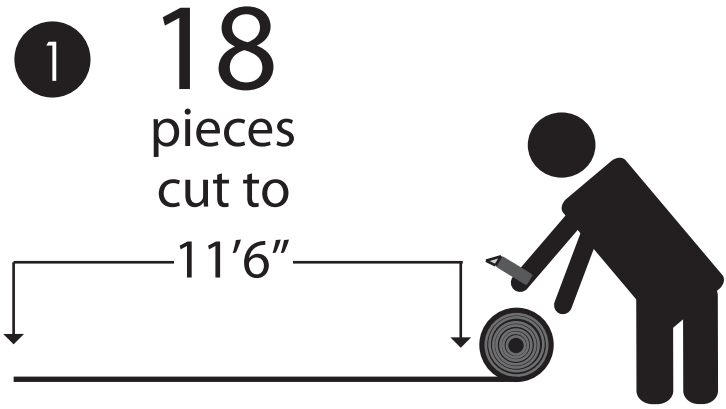

CHICKEN WIRE

1

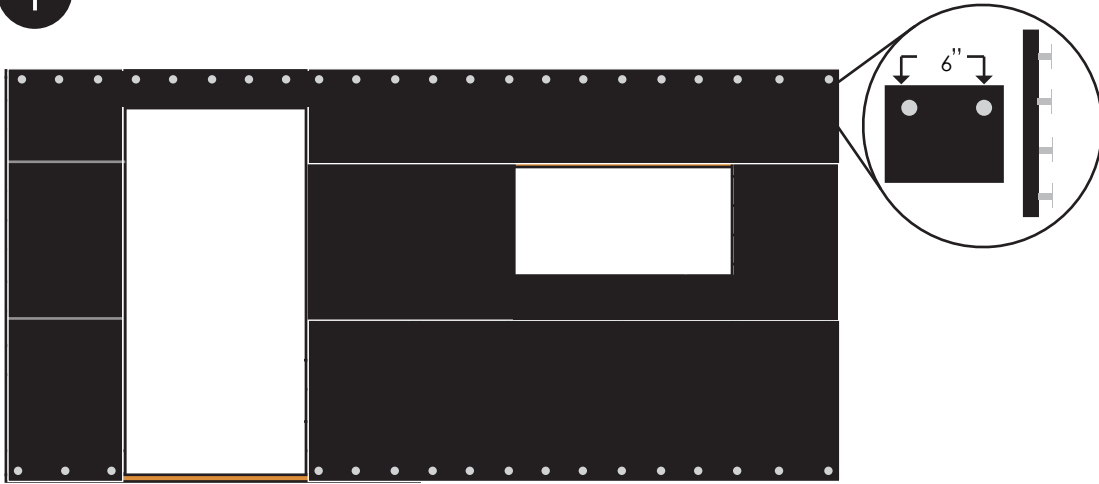

2

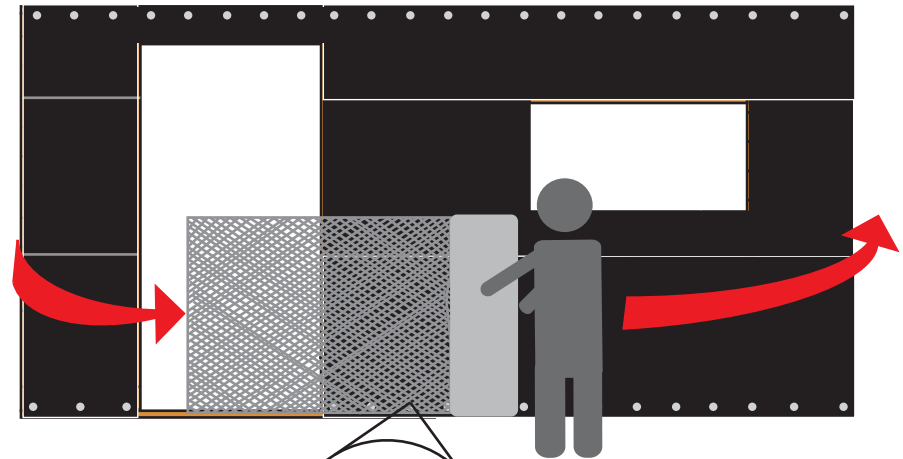

3

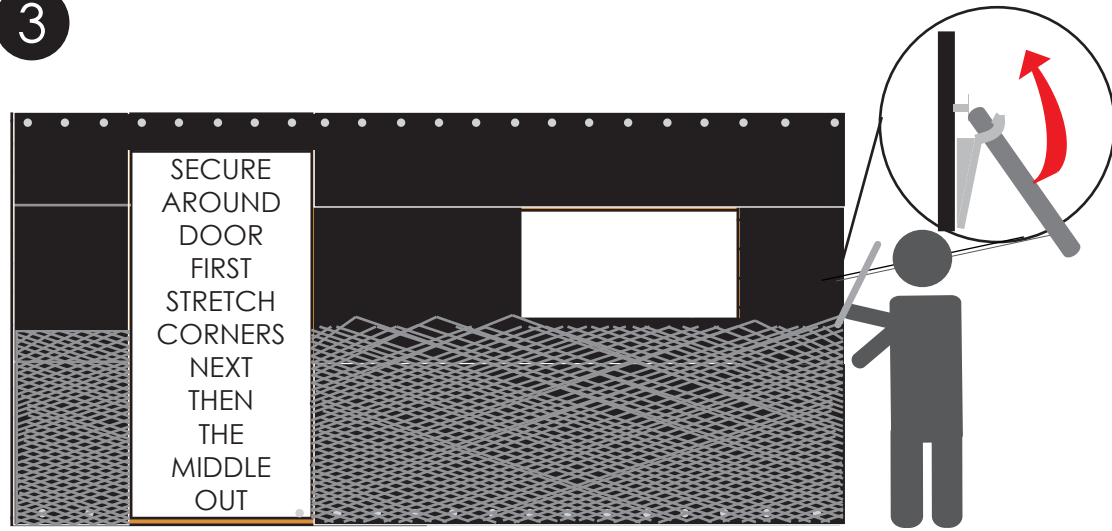

4

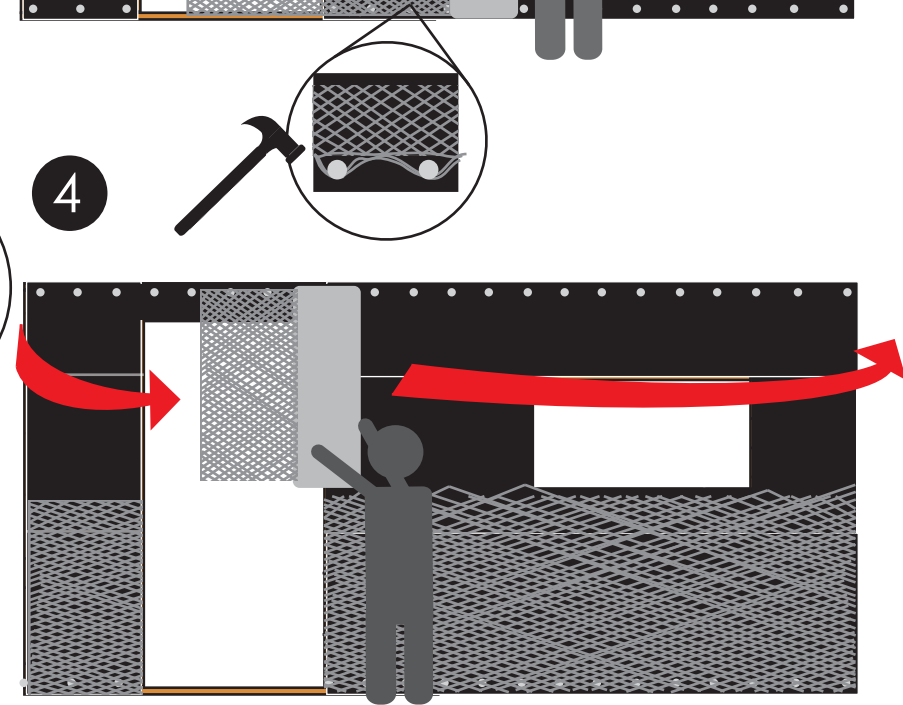

1

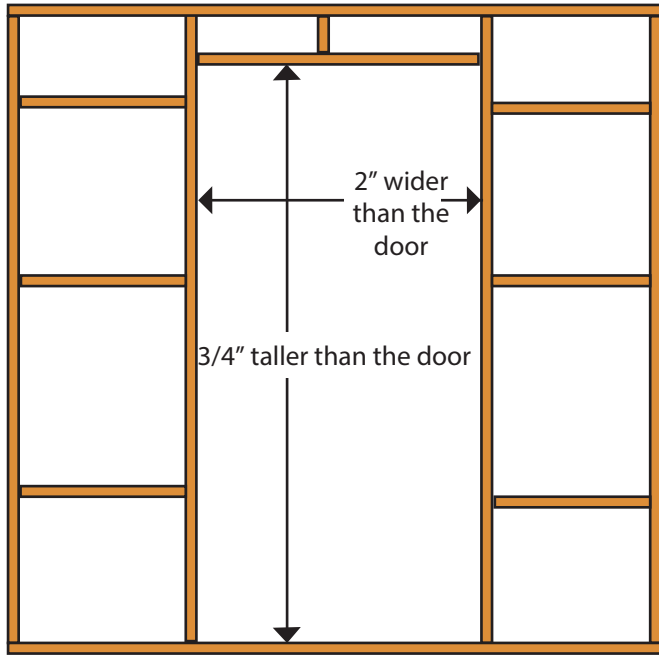

Door may not be 80"x36"

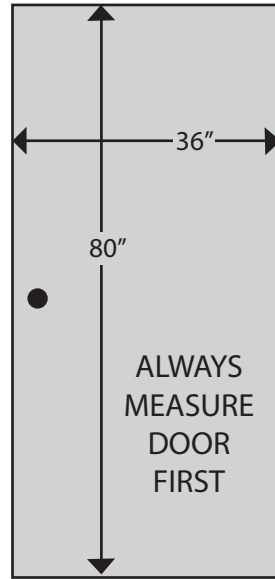

2

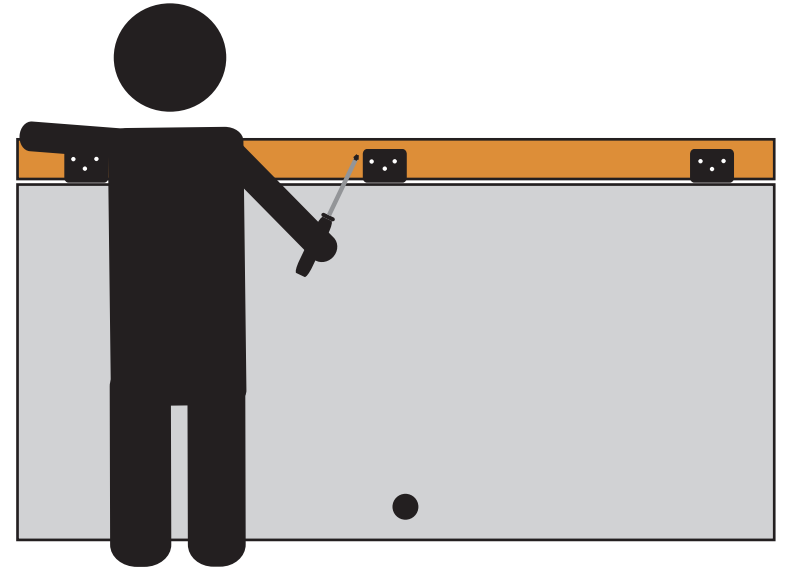

3



4

SHIMS
*not provided

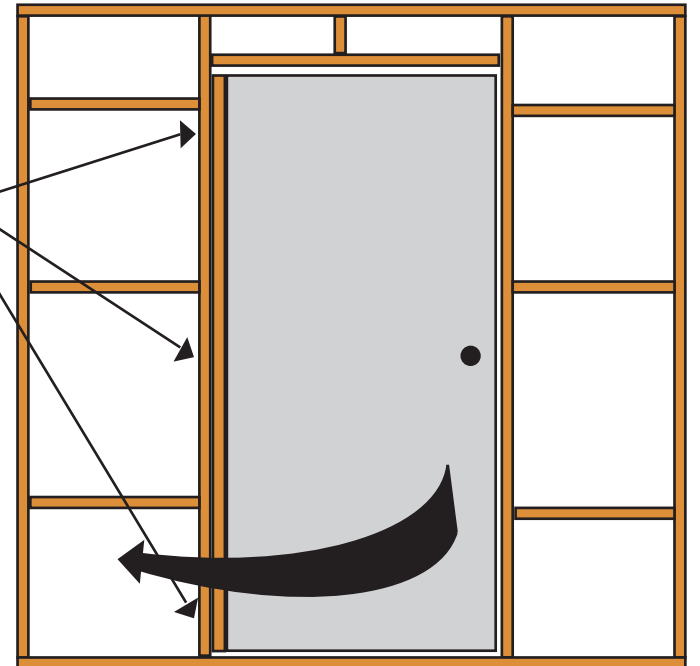

WINDOW WITH CHANNEL

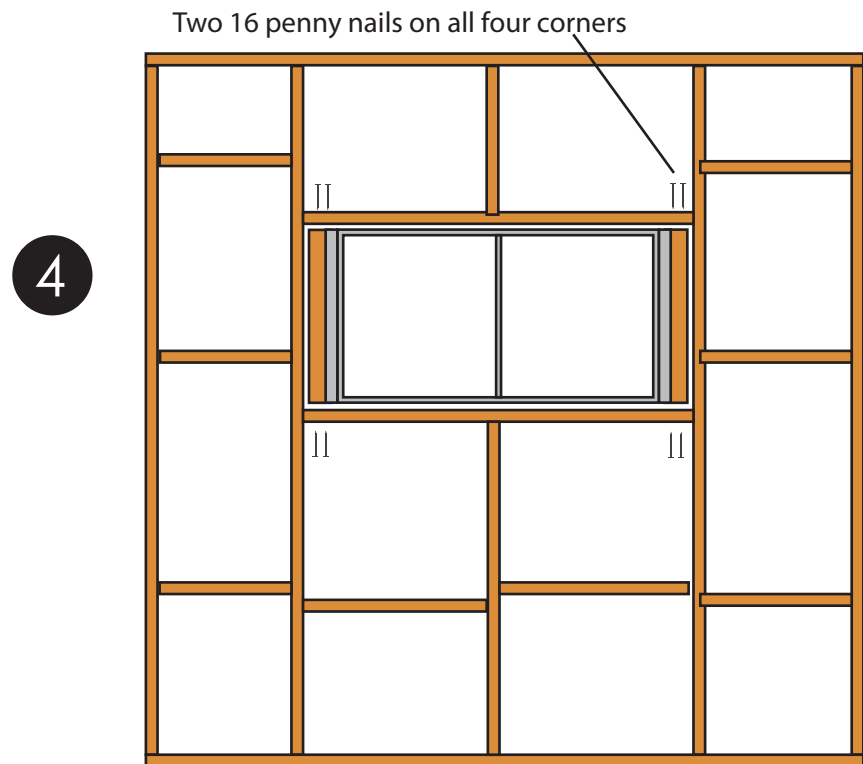
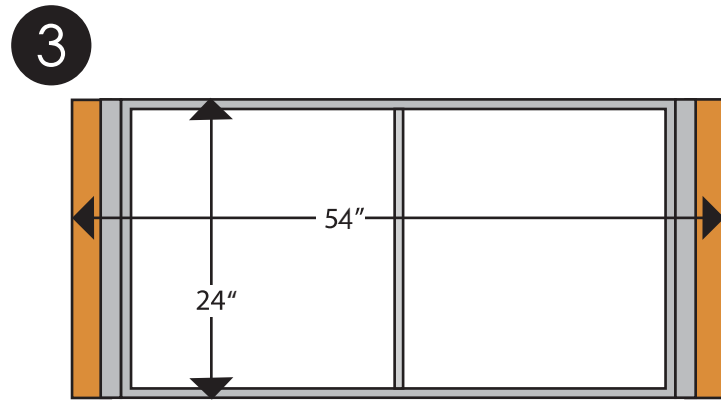
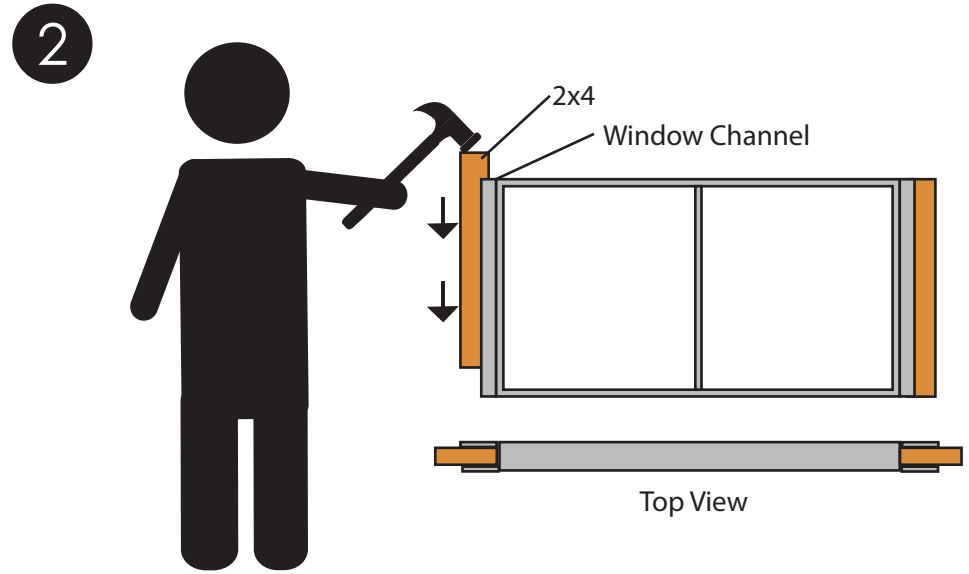
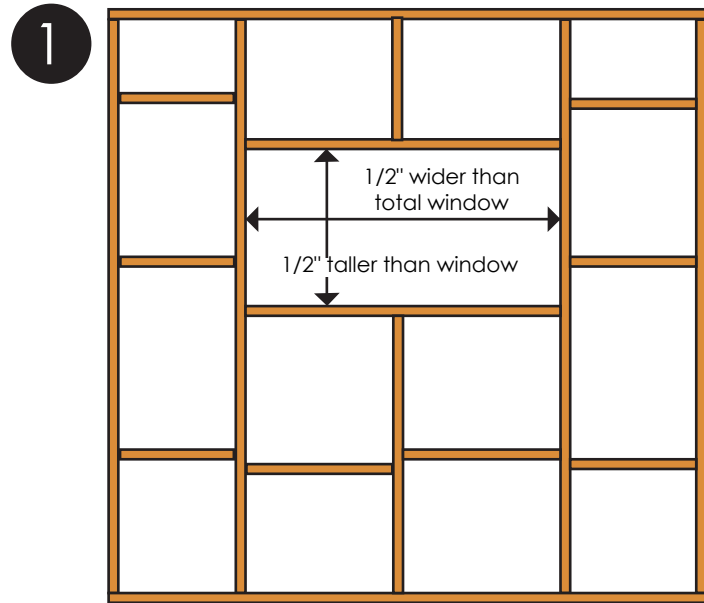

ROOF

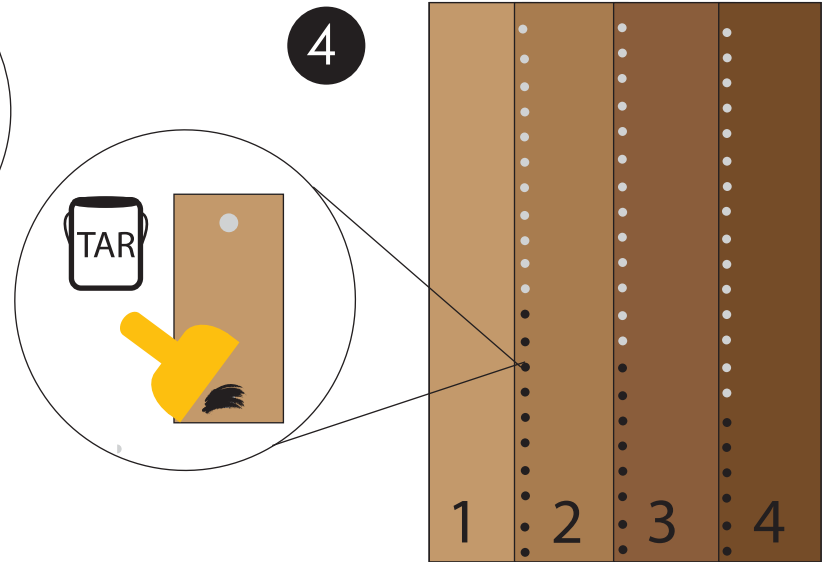
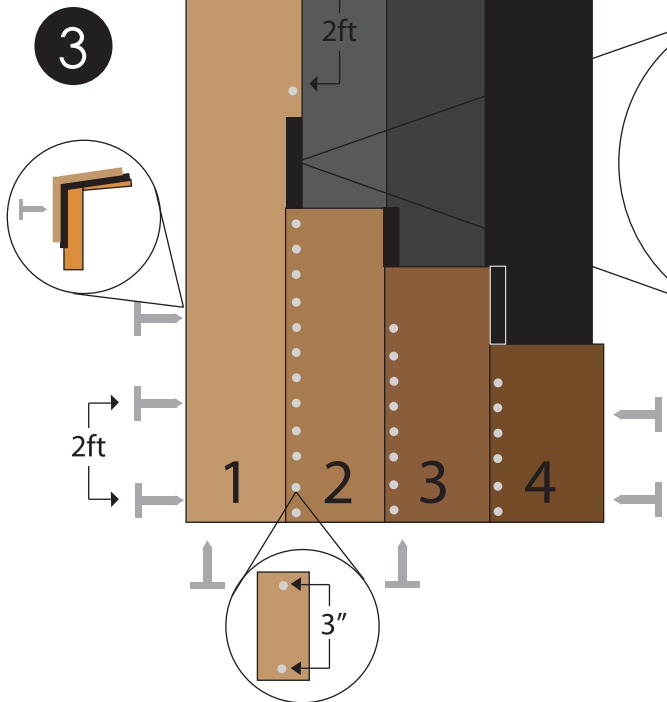
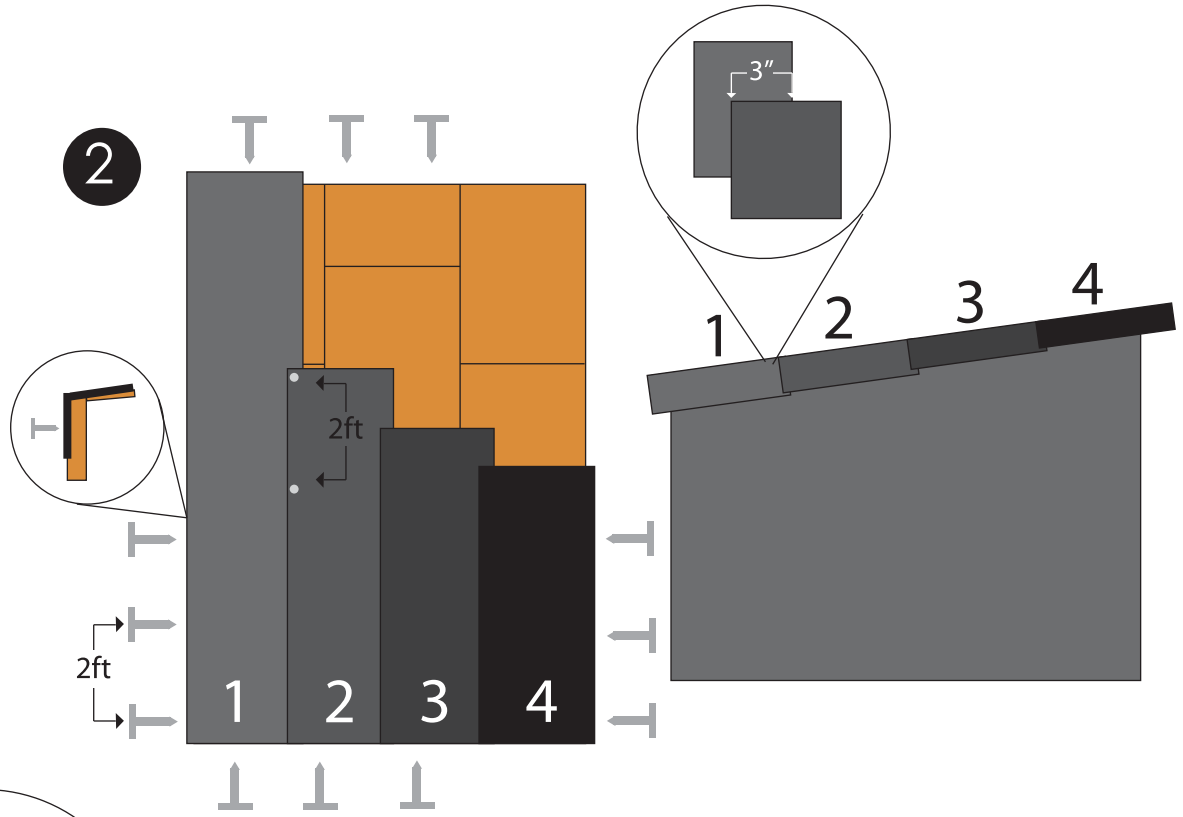
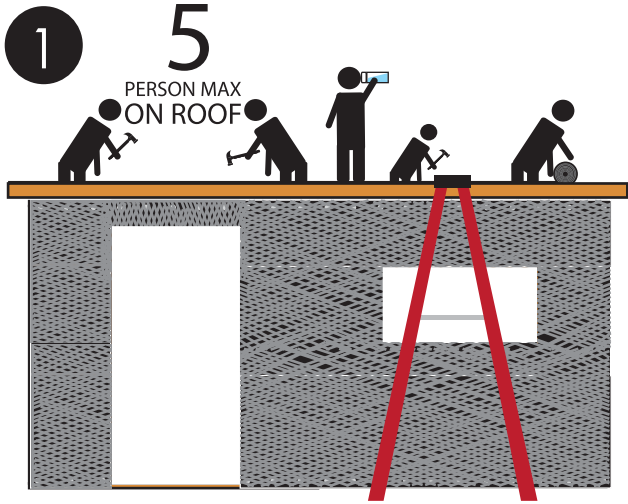

STUCCO

1

FIRST COAT

14 SHOVELFULS OF SAND
1/2 BAG OF CEMENT

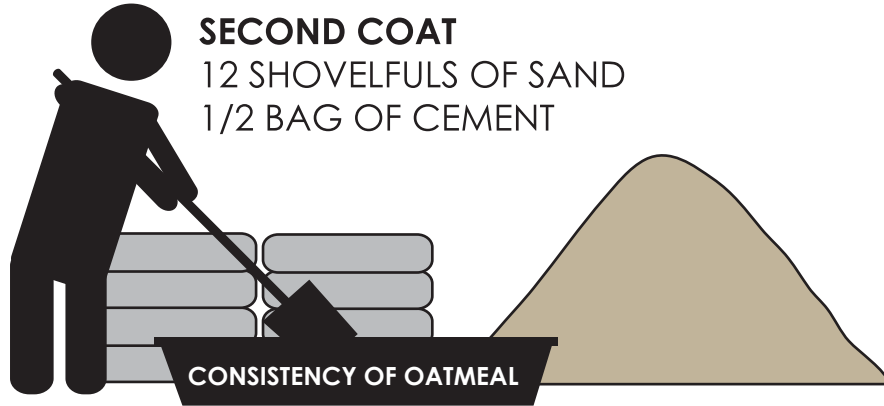

SECOND COAT

12 SHOVELFULS OF SAND
1/2 BAG OF CEMENT

2

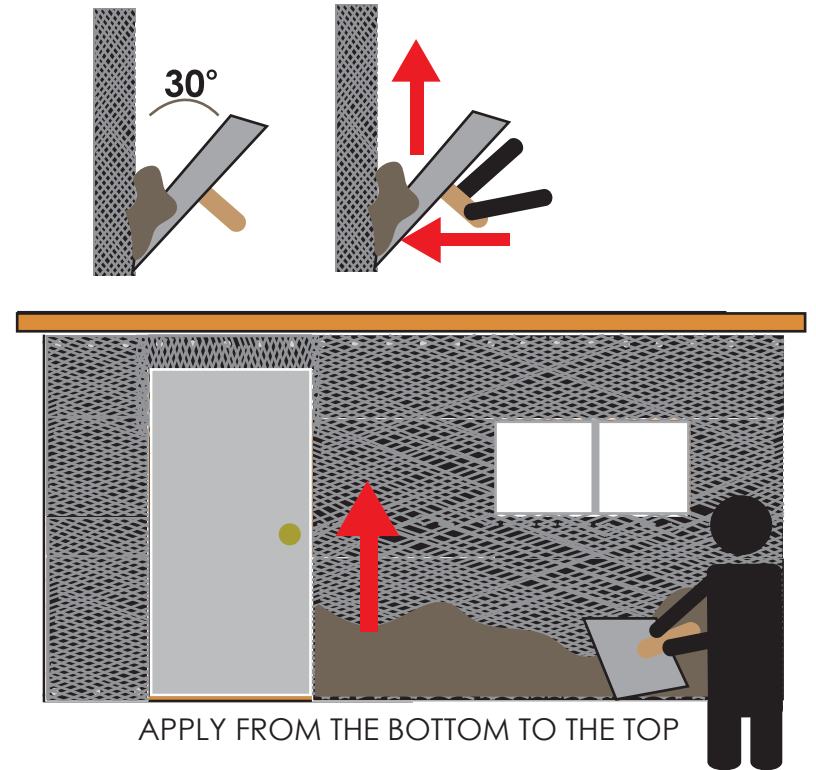

3

